



Crystal Quest® Point-of-Use Bottleless Water Cooler INSTALLATION AND OPERATION GUIDE



MODELS:

- | | | |
|--------------|--------------|--------------|
| CQE-WC-05901 | CQE-WC-05903 | CQE-WC-00906 |
| CQE-WC-05907 | CQE-WC-05908 | CQE-WC-00900 |
| CQE-WC-05902 | CQE-WC-05909 | CQE-WC-00910 |
| CQE-WC-00900 | CQE-WC-00902 | |

ONLINE WARRANTY INFORMATION
CrystalQuest.com/warranty.html

Copyright 2018
Crystal Quest®
All rights reserved
MADE IN THE USA





i IMPORTANT INFORMATION

- Do not lay the cooler on its side. The system must be in an upright position at all times. When carrying, do not lift the system by the faucets/spouts.
- The system needs to be installed by a licensed plumber in any state or country; however, the following states specifically require a licensed plumber to install the system OR allow a state-registered installer or contractor: AR, CA, GA, KS, MA, MI, MN, OK, RI, SC, SD, TX, VT, and Wi.
- A pressure regulator, such as a slow-flow regulator, must be installed in front of the unit’s water inlet if the water pressure (including any possible pressure spikes) could exceed 60 psi. Failure to comply will void the warranty. Crystal Quest® accepts no liability for damage caused by excessive water pressure or improper installation.
- Installation must be made within a protected area covered from the elements and freezing. The unit must be protected from rain, dust, flooding, snow, freezing, and direct sunlight (the system’s direct exposure to sunlight may cause algae growth in the tank reservoir). Failure to comply will void the warranty.
- Use only ¼” OD tubing to connect the cold water supply to the system.
- Check all the connections (i.e., water hose/tubing, connectors/fittings) to ensure proper connection and avoid leaks.
- Check plumbing inlet and outlet to ensure the proper flow of water through the system.
- Plug the system into a 110 volt grounded outlet which contains a fuse or circuit breaker of 20 amps.
- Locate the system near a COLD water supply line. Do not set the system farther than 15 ft. from the cold water line. Do not use on hot water line. Use copper tubing to avoid water line puncture and rodent bites. Failure to do so may cause major property damage. Crystal Quest® accepts no liability for damage.
- Install the system in a well-ventilated area where the temperature is consistently between 60° - 100°F.
- System must have a 2” clearance on all sides to ensure proper ventilation.
- Install the auto shut-off valve to control and reduce the cold water supply line pressure to 25 psi and maintain at 25 psi to avoid bursting.
- Hot water tank must be filled with water before the heating on/off switch is turned on.
- Do not use the system on cold water supply line with less than 20 psi.
- Do not move the cooler if filled with water.
- Do not use non-Crystal Quest® replacement cartridges.
- Do not use non-Crystal Quest® parts or modify/tamper with unit.

TABLE OF CONTENTS

Important Information	2
System Specifications	3
Installation Instructions	4
Circuit and Installation Diagrams	6
Install Water Cooler System to Water Supply	7
Service Information and Guidelines	9
Troubleshooting Guide (Water Problems)	10
Troubleshooting Guide (Unit Problems)	11
Access to Parts Inside the System	12
Water Cooler Heating Reservoir Replacement Guide	13
Water Coolers (Optional Cartridges & Accessories)	14
Replacement Cartridges	15
How to Avoid Accidental Property Damage	16
Installing Leak Detector	18
Frequently Asked Questions	19
Warranty Information	20



SYSTEM SPECIFICATIONS



CRYSTAL QUEST® TURBO FLOOR WATER COOLER

Weight: 45 lbs.
 Dimensions: (D) 13" x (W) 13" x (H) 37.5"
 Total reservoir capacity: 1.3 Gal
 Hot water tank temperature: 176-194°F
 Heating power: 500W 6.2 Amp
 Cooling power: 112W 2.4 Amp
 Hot water tank volume: 0.5 Gal
 Heating Capacity: 1.45 Gal per hour
 Cold water tank volume: 0.8 Gal
 Cooling capacity: 1.95 Gal per hour
 Voltage: 110V-120V 50/60Hz

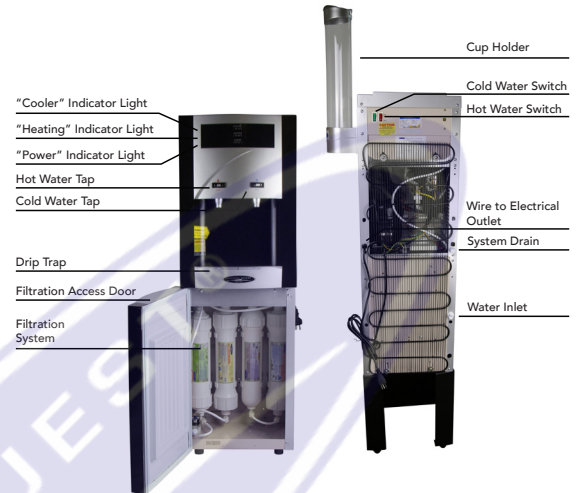

CRYSTAL QUEST® TURBO COUNTERTOP WATER COOLER

Weight: 34 lbs.
 Dimensions: (D) 13" x (W) 13" x (H) 18.5"
 Total reservoir capacity: 1.3 Gal
 Hot water tank temperature: 176-194°F
 Heating power: 500W 6.2 Amp
 Cooling power: 112W 2.4 Amp
 Hot water tank volume: 0.5 Gal
 Heating Capacity: 1.45 Gal per hour
 Cold water tank volume: 0.8 Gal
 Cooling capacity: 1.95 Gal per hour
 Voltage: 110V-120V 50/60Hz

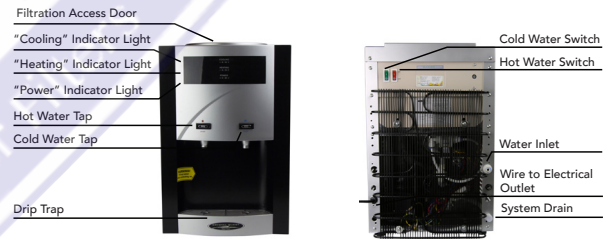

CRYSTAL QUEST® SHARP FLOOR WATER COOLER

Weight: 48 lbs.
 Dimensions: (D) 13" x (W) 13" x (H) 42"
 Total reservoir capacity: 1.3 Gal
 Hot water tank temperature: 176-194°F
 Heating power: 500W 6.2 Amp
 Cooling power: 112W 2.4 Amp
 Hot water tank volume: 0.5 Gal
 Heating Capacity: 1.45 Gal per hour
 Cold water tank volume: 0.8 Gal
 Cooling capacity: 1.95 Gal per hour
 Voltage: 110V-120V 50/60Hz

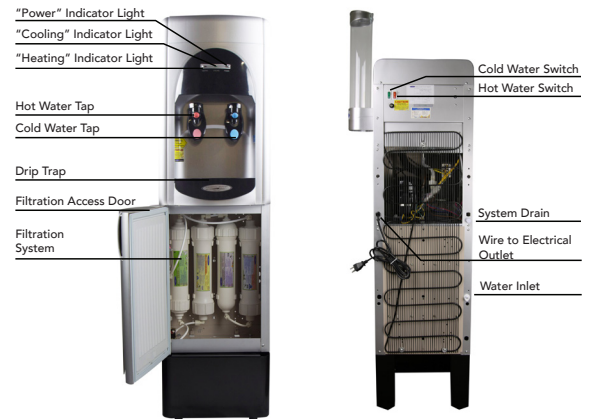



SYSTEM SPECIFICATIONS



CRYSTAL QUEST® HYBRID FLOOR WATER COOLER

Weight:	60 lbs.
Dimensions:	(D) 17.6" x (W) 14.4" x (H) 42"
Total reservoir capacity:	1.5 Gal
Hot water tank temperature:	185°F
Heating power:	500W 6.2 Amps
Cooling power:	112W 2.4 Amps
Hot water tank volume:	0.5 Gal
Cold water tank volume:	0.4 Gal
Cooling capacity:	1 Gal per hour
Voltage:	110V-120V 50/60Hz

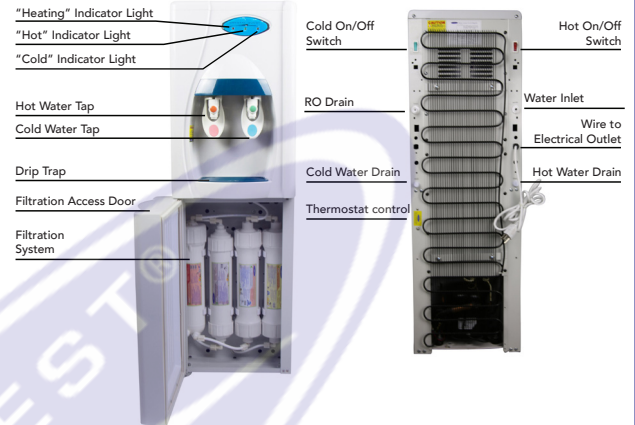

Accessing Internal Parts

1. Turn off heating and cooling switches.
2. Shut off water supply to the system.
3. Drain water from drain ports on the back of system and unplug power cord.
4. Remove two screws attaching top to back of system.
5. Remove top of system and the top of holding reservoir.
6. Remove screws attaching back of system to the cabinet and remove holding reservoir.
7. Access is now available for most of the internal parts of the system for repair or replacement.

INSTALLATION INSTRUCTIONS

1. ARRIVAL INSPECTION

- Inspect the carton and water cooler for evidence of rough handling and concealed damage. If contents appear damaged, ask driver or contact carrier for a damage claim form to fill out. Shipper must be notified immediately.
- Remove the carton, top packaging tray, and shipping bag from the system. Remove system from the bottom inflammable packing material and carton tray.
- Inspect the system further, ensuring that:
 - o There is no physical damage to the system.
 - o All accessories are present.
 - o The hot tank switch is in the "OFF" position.
 - o The cooler is clean and dust-free.

2. LOCATION

Select the location for the system with care. Various conditions which contribute to proper location are as follows:

- Locate as close as possible to water supply source.
- Locate as close as possible to a three-prong grounding receptacle.
- Locate the system on a smooth and level floor.
- Allow sufficient space around the system for easy servicing.
- Provide a non-switched 110/120V, 60Hz power source for the system.
- Make sure the system is not moved, tilted, OR shaken. Any of these will result in water spillage and may cause property damage. CRYSTAL QUEST® accepts no liability for damage.
- Make sure the system is not within reach of children. The system does not have a child safety device.
- Do not locate the system where the environment would offer any risk of water contamination.
- Do not locate the system within or directly adjacent to toilet facilities.
- Do not put any liquid other than water into the system.
- Do not lay the system on its side.
- Do not leave the system on without water supply line running.
- Install water cooler in an area protected from flooding, rain, direct sunlight, dust, snow and freezing. The warranty does not cover damage incurred as a result of exposure to the weather.

3. CLEARANCES

Allow two inch clearance on sides, top, and back for ease of installation, proper air circulation and plumbing and electrical connections.

- Do not install the water cooler where the temperature will go below 60°F (16°C) because it will not run often enough to maintain proper temperature.
- Do not install the water cooler where the temperature will go above 100°F (37°C) because it will not perform properly.
- Install water cooler on a floor strong enough to support it when fully loaded with water.
- If the water cooler is against a wall on either side, allow a 1/8" (3 mm) door clearance.



INSTALLATION INSTRUCTIONS *WER*

IMPORTANT – Observe all governing codes and ordinances.

4. SAFETY INFORMATION

- Read the instructions carefully and learn the specific details regarding installation and use. Failure to follow them could cause serious property damage. CRYSTAL QUEST® accepts no liability for property damage.
- The system should be installed to meet local, state and federal plumbing codes and health department rules and regulations. You must follow these guidelines as you install the water cooler system.
- All equipment should be plumbed into the water system by a licensed, qualified plumber.
- Check with your local public works department for plumbing codes.
- The system is for indoor use only.
- The system will stand up to 60 pounds per square inch (psi) water pressure. We recommend installing a pressure reducing valve before the system. This will reduce the water pressure flow to the system and will prevent pressure build-up on the system when not in use. The most common operating water pressure range is 35-65 psi.
- Turn the cold water line off while installing the system.
- A hard impact or jarring of the system will cause fill float to fail and may cause major property damage. CRYSTAL QUEST® accepts no liability for property damage.
- Water will discharge if the top of the reservoir is not placed properly or seated securely (the reservoir top needs to be placed fully onto the reservoir tower), or the unit has been shaken or tilted, causing the floater to get stuck.
- Make certain the electrical outlet is grounded by having it checked by an electrician or by using a UL listed circuit analyzer. Units are furnished with 3-prong grounded plugs to protect you against the possibility of electric shock. Do not under any circumstances remove the ground prong and never splice or cut the electrical cord.
- The outlet must be within reach of the power cord. Do not use an extension cord. Extension cords that are too long or too light do not deliver sufficient voltage to the unit and could present a safety hazard.
- Disconnect power before installing or servicing unit. Do not plug unit in or change fuses while standing on wet or damp surfaces and do not touch any other metal surfaces while plugging in product or changing fuses.
- All water treatment installations must conform to local plumbing, electrical and sanitation codes. These codes are established for your protection.
- When installation is complete, dispense water from the hot and cold water spouts and run water until there is no more air in the lines.
- When installation is complete, re-check the system to make sure there are no leaks or drips.

CAUTION: Fill the unit with water; dispense a cup of water through each spout before turning on the heating switch.

WARNING: A pressure regulator, such as a slow-flow regulator, must be installed in front of the system's water inlet if the water pressure is above 60 psi (including any possible pressure spikes). Failure to comply will void warranty. Crystal Quest® accepts no liability for damage caused by excessive water pressure or improper installation.

Do not use this drinking water system where the source water is microbiologically unsafe or with water of unknown quality.

5. PRE-INSTALLATION INSTRUCTIONS (Before you begin, read these instructions completely and carefully.)

- This water line installation is not warranted by the water cooler manufacturer. Follow these instructions carefully to minimize the risk of expensive water damage.
- Water hammering (water banging in the pipes) in house plumbing can cause damage to water cooler parts and lead to water leakage or flooding. Call a qualified plumber to correct water hammering before installing the water supply line to the water cooler.
- To prevent burns and product damage, do not hook up the water cooler to the hot water line.
- Do not install the water cooler and/or water cooler tubing in areas where temperatures fall below 60°F. When using any electrical device (such as a power drill) during installation, be sure the device is double insulated or grounded in a manner to prevent the hazard of electrical shock, or is battery powered.
- All installations must be in accordance with local plumbing code requirements.
- Use copper or a Crystal Quest® tubing kit (1/4" outside diameter) to connect the water cooler to the water supply. If using copper, both ends of the tubing must be cut square.
- To determine how much tubing you need, measure the distance from the water valve on the back of the water cooler to the water supply pipe then add about 10" (25 cm) to allow the water cooler to move out from the wall after installation.

NOTE: The only Crystal Quest® approved polytubing is that which is supplied in the Crystal Quest® water cooler tubing kit. Do not use any other plastic water supply line because the line is under pressure at all times. Certain types of plastic will crack or rupture with age and cause water damage to your location. Crystal Quest® accepts no liability for property damage.

NOTE: The hot tank switch should be in the "OFF" position before and during installation.

IMPORTANT – Save these instructions for local inspector's use.

IMPORTANT – Observe all governing codes and ordinances.

Note to Installer – Be sure to leave these instructions with the Consumer.

Note to Consumer – Keep these instructions for future reference.

Skill Level – Installation of this water cooler requires basic mechanical skills.

Proper installation is the responsibility of the installer.

Product failure due to improper installation is not covered under the warranty.

CIRCUIT AND INSTALLATION DIAGRAMS

Turbo/Sharp
Floor/Countertop
Point-of-Use
Water Coolers

Circuit Diagram

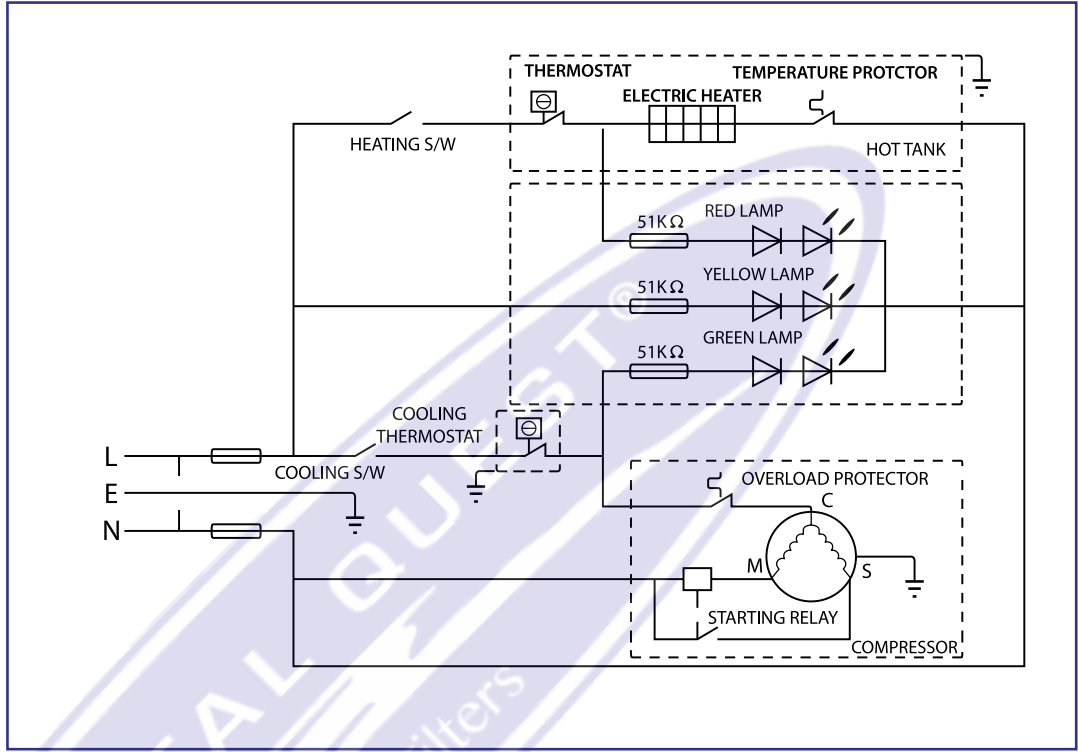

Turbo/Sharp
Floor
Point-of-Use
Water Coolers

Install to cold water supply line

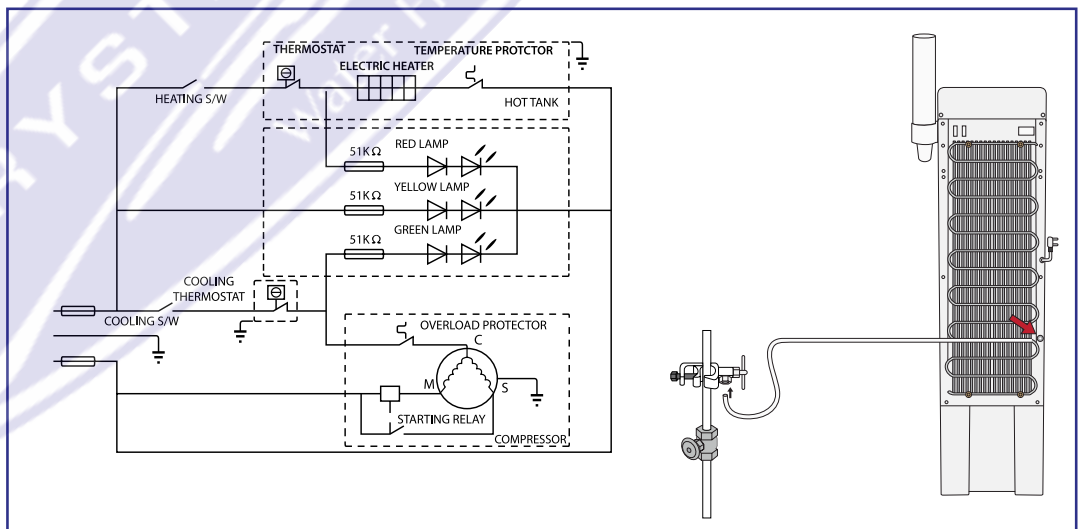

Turbo/Sharp
Countertop
Point-of-Use
Water Coolers

Install to cold water supply line

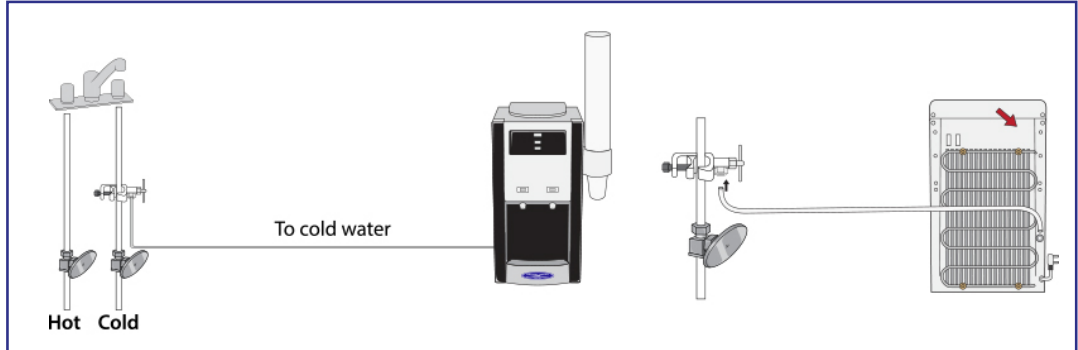



INSTALL WATER COOLER SYSTEM TO WATER SUPPLY

6. SYSTEM SET-UP & PREPARATION

CAUTION: Adjust the cold water supply line at the T-Valve (Fig 1) by slowly turning the handle to reduce flow to the system.

- Connect the water supply line tubing to the system access board labeled "water inlet". The system is shipped with a red cap; remove it before inserting the tube.
- Turn on the cold water supply line again. Make sure there is no leak at the connections. Recheck for water leaks.
- Plug the power cord into a receptacle outlet. Make sure the system is plugged into a 110 volt grounded outlet which contains a fuse or circuit breaker of 20 amps.
- Turn the shut-off valve handle to the "ON" position to allow the cold water to flow through the system. Check that water flows through the cold faucet; water will not flow if electrical is not plugged in.
- Allow the water to flow through the system. Check all connections including the filters and all other tubing and fitting connections inside the system for possible leaks.
- Dispense the hot and cold water faucet/spouts and run until water flows freely and there is no air in the lines. Be careful: water from hot faucet can scald your hands.
- Allow water to flow through the system to refill the cold and hot tanks.
- Flush filters/membrane (refer to number 7 below).
- Turn on the hot and cold tank switches.
- Do not use the first three reservoirs of water. These flush the system.

CAUTION: FLOOD STOPPER VALVE, OR FLOOD PREVENTION VALVE, SHOULD BE INSTALLED ON ANY WATER COOLER, BUT MUST BE INSTALLED ON THE WATER COOLER IF THE WATER COOLER IS INSTALLED IN A HIGH RISE BUILDING. AFTER INSTALLATION RECHECK THE SYSTEM FOR WATER LEAKS.

7. FILTERS / RO FLUSHING PROCEDURES

The following procedures will prepare the system to deliver the best possible drinking water.

1. Ensure that filters are installed, hot and cold switches are off, the system is plugged in, and the top of the cabinet and the reservoir lids are off.
2. Allow water flow to fill the reservoir and drain the system three times. Avoid water spills, and use a pan to catch the water from both drains.*
3. Refill the reservoir and cover cabinet by replacing lids. Turn both switches on after tanks are full.
4. Dispense two glasses of water from each faucet/spout to clear trapped air.

NOTE: This drained water should be immediately disposed of properly (poured down a drain) to prevent accidental spilling, as this water may stain.

8. INSTALLING THE SADDLE VALVE

A. Choose the valve location.

- Choose a location for the valve that is easily accessible. It is best to connect into the side of a vertical water pipe. When it is necessary to connect into a horizontal water pipe, make the connection to the top or side, rather than at the bottom, to avoid drawing off any sediment from the water pipe.
- Disconnect the cold water supply line. Attach and tighten the saddle valve connector assembly, being careful not to pinch or crimp any tubing or water supply line while tightening. Use thread seal tape to ensure a tight fit (Fig 2).

NOTE: The saddle valve (Fig 2) clamps onto soft or hard tubing or pipe. It will make its own hole in copper tubing but not in iron or brass. For brass or galvanized iron pipe, drill a 1/4" hole in pipe before mounting saddle valve.

CAUTION: There is risk of electric shock. If possible, use a hand or cordless drill when drilling into the water pipe. Be sure that drill, cord, and outlet are all properly grounded.

NOTE: Do not turn handle before installing or while installing saddle valve. To prevent damage to piercing needle, make sure that piercing lance does not project beyond the rubber gasket.

NOTE: Leave handle in this position (valve closed) until filter installation is complete.

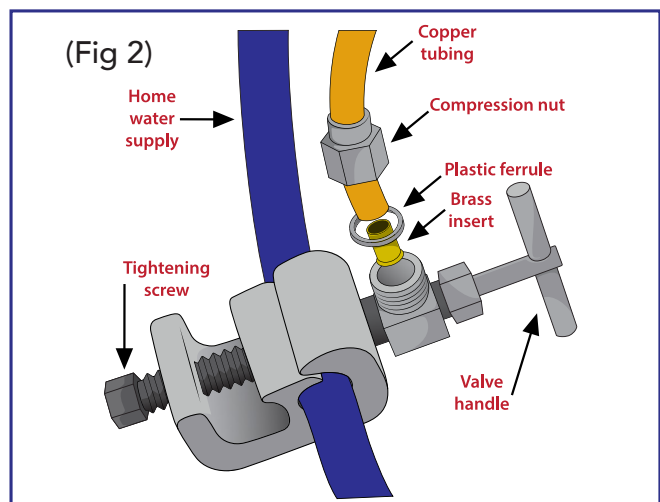
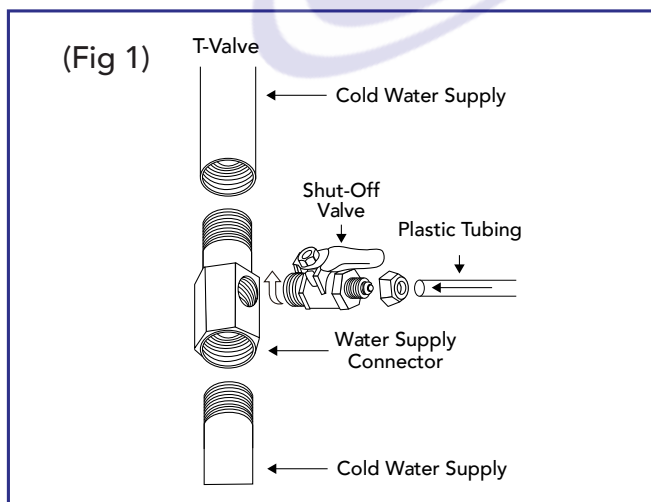



INSTALL WATER COOLER SYSTEM TO WATER SUPPLY *CONTINUED*

B. Assemble saddle-tapping valve assembly on tube.

1. Hold back plate against tube.
2. Hold saddle valve against tubing in a position directly opposite back plate.
3. Tighten screw so saddle valve and back plate are held securely against tube.
4. Tighten screw firmly. Do not crush tube.

C. Connect source water feed tubing to valve body using compression fitting.

1. Slide nut and sleeve onto tubing (in that order).
2. Install insert into plastic tubing.
3. Install tube with insert and sleeve into valve body.
4. Thread compression nut onto valve body. Tighten.
5. Turn saddle-tapping valve handle clockwise until it is firmly seated and piercing lance is fully extended.

CAUTION: Supply line is pierced and valve is closed. Do not open valve until system is activated. Turn on cold water supply. Check saddle-tapping valve installation for leaks. Allow water to run from faucet for a few minutes to clear any debris in the line caused by installation.

NOTE: If flow from sink faucet is reduced, clean faucet aerator.

NOTE: Connect the water supply line tubing to the system access board labeled "water inlet". The system is shipped with a red cap; remove it before inserting the tube.

T-VALVE INSTALLATION (FIG 1)

WARNING: Water supply pressure must not exceed 60 psi.

NOTE: T-Valve is designed for installation on flex line tubing.

NOTE: Always check the local plumbing codes before tapping into a water line.

1. Turn off cold water supply.
2. Assemble T-Valve by screwing and tightening the shut-off valve into the water supply connector. Use thread tape on threads.
3. Disconnect source water feed tubing from cold water supply.
4. Install T-Valve assembly in line with water feed tubing and water supply.
5. Remove nut from feed end of shut-off valve and slide over filter supply tubing.
6. Press end of tubing over exposed nipple on shut-off valve. Ensure it is completely seated.
7. Slide nut down tubing and tighten securely to shut-off valve.
8. Slowly turn on cold water supply and check for leaks.
9. Open T-Valve shut-off valve slowly to supply water to filter.

For further instructions on T-Valve assembly, see T-Valve product label.

9. SERVICING THE FILTER (FIG 3)

1. Shut off water at the water supply line.
2. Turn off hot and cold water switches.
3. Unplug the cord from outlet.
4. Drain tubing completely.
5. Disconnect tube from filter.

CAUTION: HOT WATER WILL SCALD.

10. CHANGING FILTER CARTRIDGES

1. Loosen the connector fitting counterclockwise (Fig 4).
2. Pull the cartridge out of the main fold.
3. Wrap the connector fitting with thread seal tape and connect it to a new cartridge (Fig 5).

11. CHANGING CARTRIDGES IN SYSTEM

1. Remove two screws from the back (Fig 6).
2. Pull the lid up to locate the cartridge (Fig 7).
3. Loosen the connector fittings by turning them counterclockwise (Fig 8).
4. Pull the cartridge out of the main fold.
5. Wrap the connector fitting with thread seal tape and connect it to a new cartridge (Fig 9).

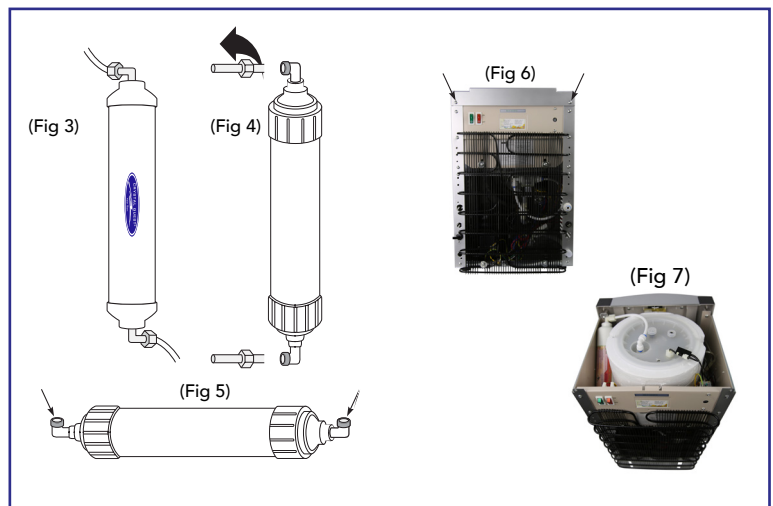



SERVICE INFORMATION AND GUIDELINES

12. CHANGING MEMBRANES

1. Loosen the connector fitting counterclockwise (Fig 10).
2. Remove the membrane housing cap by turning counterclockwise.
3. Remove the membrane with a pincer (Fig 11).
4. Insert the membrane by carefully pushing the spigot end into the socket at the far end of the housing until completely in (Fig 12).
5. Wrap the connector fitting with thread seal tape and connect it to the tubing (Fig 13).

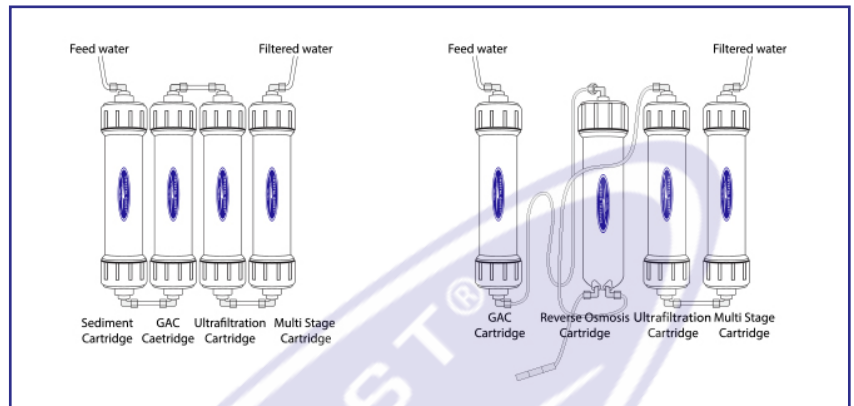

13. CLEANSING THE CONDENSER

1. The back static condenser on the rear of the unit must be kept clean of dirt and lint. Visually inspect every 3 months. To clean it, follow these steps:
 - a. Unplug the cooler.
 - b. Clean the condenser with a small, stiff, non-wire brush.

14. SANITIZING THE SYSTEM

1. Turn off hot and cold switches, then turn off water supply.
2. Disconnect the power supply from the cooler.
3. Drain hot-cold water tank and water from the reservoir by opening the system drain.
4. Drain water from the reservoir and hot tank (if fitted) through the faucets.
5. Wash hands thoroughly.
6. Put on disposable gloves.
7. Wash the faucets and reservoir using mild cleaning agent. Parts **MUST** be completely submerged in solution. Rinse with clean water immediately.
8. Reassemble the water cooler using the sanitized components.
9. Sanitize hot and cold tank (if fitted) and entire cooler with a new batch of sanitizing solution.
10. Completely fill the cooler with sanitizing solution and let stand for 5 minutes.
11. Drain solution through hot and cold tank drain (if fitted) or through faucets.
12. Rinse with clean water immediately.
13. Reconnect the cold supply line to cooler's inlet tube.
14. Flush the reservoir at least three times to remove any traces of sanitizing solution.
15. Use chlorine test kit to identify the presence of any contaminants.
16. If contamination still exists, repeat steps 13 and 14.
17. Clean the outside of the cabinet and the drip tray, using a mild cleaning agent.
18. Reconnect the power supply to the cooler.

CAUTION: FAILURE TO TURN OFF HOT TANK COULD CAUSE PHYSICAL DAMAGE TO THIS UNIT.

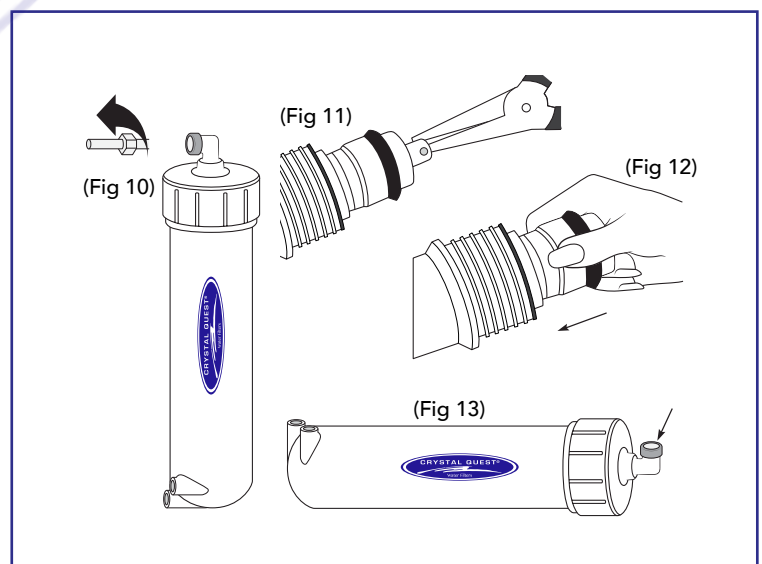
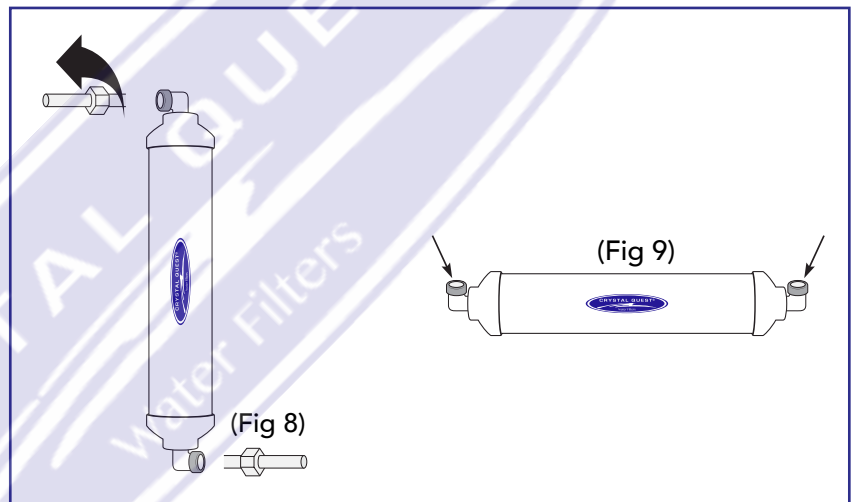



TROUBLESHOOTING GUIDE

Problem	System	Probable Cause	Solution Checklist
No water	Turbo Sharp	<ul style="list-style-type: none"> Water supply is turned OFF. Floater has tripped. 	<ul style="list-style-type: none"> Turn water ON. Verify Crystal Quest® water shut-off valve is open. Lift off cabinet top, remove reservoir's lid, and adjust the floater.
No enough water	Turbo Sharp	<ul style="list-style-type: none"> Water supply is blocked. Clogged filter cartridges are restricting water flow. 	<ul style="list-style-type: none"> Clear restriction, rotate valve handle on tap water feed valve and check the mechanical float. Replace Cartridge #3 and check the other cartridges.
Leak	Turbo Sharp	<ul style="list-style-type: none"> Fitting not properly installed. Tubing is not pushed completely into fitting. Defective tube. Worn or damaged fitting and/or O-ring. The floater is stuck. Tube has burst. 	<ul style="list-style-type: none"> Reinstall. Push the tubing further onto fitting. Cut damaged area off tube or replace tube. Replace fitting and/or O-ring. Lift off cabinet top, remove reservoir lid, and adjust the fill float. Install flow-restrictor device and replace burst tube.
Water looks murky	Turbo Sharp	<ul style="list-style-type: none"> Cartridge(s) is/are depleted. Reservoir needs cleaning. 	<ul style="list-style-type: none"> Replace cartridges, clean and sanitize system. Drain reservoir, sanitize, and let it refill.
Leak at filter	Turbo Sharp	<ul style="list-style-type: none"> Stem, fitting, and/or O-ring has nick or scratches. Cartridge(s) has/have cracks or scratches 	<ul style="list-style-type: none"> Replace fitting and/or O-ring. Replace cracked cartridge(s) and install a flow-restrictor device.
Leak at water supply connector	Turbo Sharp	<ul style="list-style-type: none"> Loosen water supply connector; loosen shut-off valve. Tubing deformed. 	<ul style="list-style-type: none"> Tighten connections, reseal with thread seal tape, change O-ring. Cut damaged area off tube, or replace tube and sleeve.
No indicator lights on	Turbo Sharp	<ul style="list-style-type: none"> The system is not plugged in. Hot and cold switches turned OFF. The connectors to switches are loose. Burned fuses. 	<ul style="list-style-type: none"> Plug the system into electrical outlet. Turn switches ON (reset). Lift off cabinet top, unplug, and replug wires from switches. Replace fuses.
No drain water	Turbo Sharp	<ul style="list-style-type: none"> Clogged water drains. Hole or drain tube blockage. 	<ul style="list-style-type: none"> Clean the system. Remove drain plug.
Leaking drain assembly	Turbo Sharp	<ul style="list-style-type: none"> Drain plug or drain cover is not properly plugged or firmly tightened. 	<ul style="list-style-type: none"> Replug the drain and tighten firmly.
No hot water	Turbo Sharp	<ul style="list-style-type: none"> The system is not plugged in. Hot tank switch is turned OFF. Burned out fuse. Connector to switch is loose. Hot tank switch is tripped. Circuit needs to be reset. Hot tank needs cleaning. Hot tank thermostat failed. Cold tank switch is turned OFF. 	<ul style="list-style-type: none"> Plug the system into electrical outlet. Turn switches ON (reset). Replace fuse. Lift off cabinet top, unplug and replug wires from switch. Push the switch to reset. Turn switch OFF then back ON. Clean hot tank. Call Crystal Quest® Service Center (1-800-934-0051). Turn switches ON (reset).
No cold water	Turbo Sharp	<ul style="list-style-type: none"> Burned out fuse. Connector to switch is loose. Cold control. Water drawn in less time than the system can recover. Refrigerant loss. 	<ul style="list-style-type: none"> Replace fuse. Lift off cabinet top, unplug and replug wires from switch. Adjust the level. Let the system run for 1-2 hours and recheck. Call Crystal Quest® Service Center (1-800-934-0051).
Water – low flow (not enough water)	Turbo Sharp	<ul style="list-style-type: none"> Low water pressure. Reservoir is depleted. Clogged sediment cartridge is restricting water flow. 	<ul style="list-style-type: none"> Check water supply line pressure. Unit will not operate at less than 173 kPa (25 psi). Consider additional coolers to meet water needs. Replace sediment cartridge.
Water has an offensive taste and/or odor	Turbo Sharp	<ul style="list-style-type: none"> The system is not flushed properly. Carbon cartridge depleted. UF membrane depleted. TFC reverse osmosis membrane depleted. 	<ul style="list-style-type: none"> Empty the reservoir water three or more times. Replace activated carbon cartridge #2. Replace sediment cartridge #1 and sanitize/clean the system. Replace UF membrane cartridge #3 and sanitize the system. Replace TFC RO membrane #2 and sanitize the system.
Water reservoir will not stop filling	Turbo Sharp	<ul style="list-style-type: none"> Your float switch has malfunctioned 	<ul style="list-style-type: none"> Lift off cabinet top, remove lid, adjust floater.



TROUBLESHOOTING GUIDE *CONTINUED*

Problem	Solution Checklist
No cold water and compressor rattling	<ul style="list-style-type: none"> • Check voltage received by cooler not running. • Check cold control. • Check wires. • Check compressor relay. • Check compressor overload. • Check compressor.
No cold water and compressor running	<ul style="list-style-type: none"> • Check voltage received by cooler. • Check for a refrigerant leak. • Check for a restriction in capillary line or strainer. • Check compressor.
Water too cold or frozen	<ul style="list-style-type: none"> • Check for a refrigerant leak.
Unit runs noisily	<ul style="list-style-type: none"> • Water cooler is not level. • Check for vibrations caused by loose screws. • Check for vibrations at refrigeration lines. • Check compressor.
No hot water	<ul style="list-style-type: none"> • Check to make sure hot tank is turned on. • Check voltage received by cooler. • Check heat limiter. • Check hot control. • Check wires. • Check hot tank heating element.
No water flow from hot faucet	<ul style="list-style-type: none"> • Check water flow. • Check hot faucet. • Check for mineral build-up in hot tank.

15. SAFETY PRECAUTIONS

1. **ALWAYS UNPLUG THE SYSTEM BEFORE WORKING ON IT.** The water coolers described in this manual operate on either 110 volts, 60 hertz single phase, or on 220/240 volts, 50/60 hertz single phase. Every effort should be made to avoid electric shock.
2. **ALWAYS SHUT OFF THE WATER FLOW AT THE WATER SUPPLY LINE BEFORE WORKING ON SYSTEM.**
3. When using a volt/ohm meter in the ohms mode, be sure the cooler is unplugged.
4. When using a volt/ohm meter in the AC volts mode, be sure the meter is set on a level sufficient for the voltage in use.
5. Check to be sure the outlet provides the voltage required by the cooler.

16. EASY SOLUTIONS

Some problems have simple solutions. This section describes a couple of them.

1. NON-WORKING SYSTEM: CHECK THE VOLTAGE

The easiest solution to a non-working system may be to plug the system's service cord into an electrical outlet. Although most solutions are not usually this simple to find, do not be lulled into forgetting to check this possible cause of trouble.

Check

- Is the service plugged in?
- Is the switch controlling the outlet in the ON position?

Test

- Plug in the cooler.
- Make sure any switch controlling the outlet is in the ON position. Remove the service cord from the wall outlet and plug in a radio or similar device. If the radio works, the outlet is good.

Repair/Solution

Incorrect voltage through the outlet may need to be corrected by the local utility company. Contacting the utility is the responsibility of the customer.

2. NON-WORKING SYSTEM: CHECKING THE CUSTOMER'S NEEDS WITH THE SYSTEM'S CAPACITY

Under normal conditions, most coolers will produce 1.0 gallon of cold water (<10°C) per hour and a little more than 1.5 gallons of hot water (80°C-90°C) per hour.

Check

- A. **The temperature.** If the temperature of the room containing the cooler or the temperature of the water in the cooler is below 32°F, the cooler will not be able to provide as much cold water within the standard amount of time.
- B. **Amount of hot/cold water required in an average hour.** Find out how many persons use the cooler each hour and what size cups they are filling. Calculate the total amount of water required in an average hour.

ACCESS TO PARTS INSIDE THE SYSTEM

C. Special customer needs or large amounts of water during certain periods of the day. For example, does the customer need 9 liters of cold water at 12:45 each afternoon to fill pitchers for meeting rooms? Does the customer need 18 liters of hot water early each day when coffee or tea is prepared?

Repair/Solution

If customer's water needs are exceeding the cooler's capabilities, consider adding another cooler.

17. ACCESSING THE SYSTEM INSIDE

Before beginning the service inspection and/or repair, remove the cooler top and back covers from the cabinet.

The steps below outline the procedure for all removable reservoir coolers.

To replace parts inside the cabinet:

1. Shut off the water supply line to the system.
2. Drain water through the back of the system.
3. Unplug the power cord.
4. Remove the two top screws on back to remove the cover of the system.
5. Remove the top of the reservoir.
6. Remove the reservoir.
7. Remove the six inside screws attaching the back of the system to the cabinet.
8. Remove the two screws holding the fuse box cover in place.
9. Pull fuses to remove and replace.



B. ACCESSING FILL FLOATER

1. Unplug the system.
2. Remove two screws and remove the cabinet lid.
3. Turn switches off.
4. Unplug the connector and replug.
5. Plug the cord back into wall socket.
6. Turn the switch back on.



C. ACCESSING SWITCH CONNECTORS

1. Unplug the system.
2. Remove two screws and remove the cabinet lid.
3. Turn switches off.
4. Unplug the connector and replug.
5. Plug the cord back into wall socket.



D. ACCESSING FUSE BOX

1. Unplug the system.
2. Unscrew black screw labeled 'fuse'.
3. Remove the fuse cover.
4. Remove fuse and replace.





A. REMOVING CABINET LID

1. Remove two screws from the back.
2. Pull the lid up.



E. REPLACING SPOUTS/FAUCETS (SHARP ONLY)
Turn the knob counterclockwise to unscrew. Pull up and remove.

F. REMOVING DRIP TRAY
Pull up and remove.

G. DRAINING THE SYSTEM

1. Unscrew the drain cap and remove the drain plug.
2. Place a pan, bucket, etc. beneath to catch water.

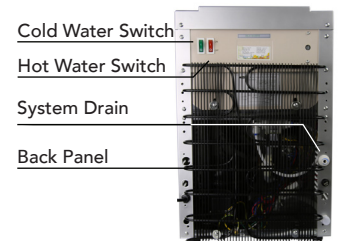
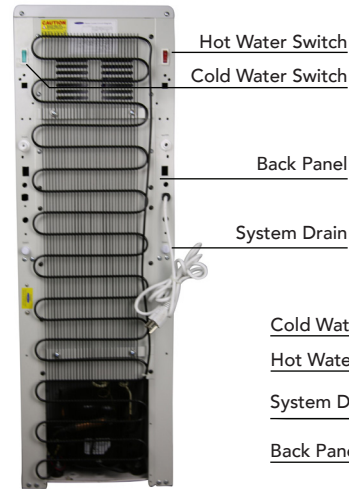
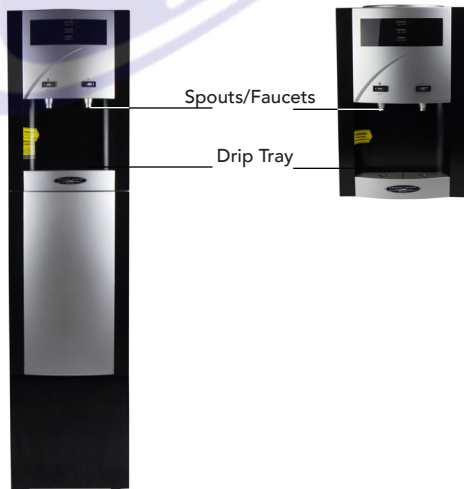



ACCESS TO HEATING RESERVOIR

Turbo and Sharp Water Cooler Heating Reservoir Replacement Guide

NOTICE:

Ensure both heating and cooling switches are turned off, power cord is unplugged from wall and water supply is turned off before servicing the machine to avoid damage or injury.

Preparation

- Turn off both the heating and cooling switches located on back of water cooler.
- Unplug power cord from electrical socket.
- Turn off water supply.
- Disconnect water supply line from back of cooler.
- Drain cooler completely of water using drain plug located on back of unit.
- Remove top from cooler, exposing the cooling reservoir; there are two screws on the back that secure the top to the machine.

Disassembly

- Disconnect the water line from the cooling reservoir.
- Unplug wiring at plug for electronic float; this is the small black wire feeding from the cooling reservoir lid.
- Remove the cooling reservoir lid by pulling up on one edge of it.
- Remove the two metal ties that secure the foam sides of the cooling reservoir. Save these for reassembly.
- Remove both foam sides that cover cooling reservoir.
- Remove six screws (two on inside near cooling reservoir and two behind drop tray on front) that secure face of machine to the body.
- Disconnect cold water and hot water supply hoses from inside of face.
- Remove cooler front face. This allows easy removal of reservoir and better working room.
- Remove the 4 screws that secure the condenser coils (black grate) to the back of the machine.
- Gently pull out on one side of the coil to allow room to access heading reservoir.

CAUTION: Pulling out too much on coil will damage coil and cooling system.

- Make labels or draw a diagram for wiring on heating reservoir; this will aid in reassembly.
- Disconnect wiring from heating reservoir.
- Disconnect drain hose from reservoir.
- Disconnect supply hose from reservoir. This hose runs from the bottom of cooling reservoir to side of heating reservoir.
- Disconnect vent hose from top of heating reservoir.
- Locate the two screws that secure heating reservoir to body. These screws are underneath the foam base of the cooling reservoir. You may need to break off a small piece of this base to locate the screws. Save this piece for reassembly.
- Remove both screws which will allow you to remove the entire heating tank from the front of the machine.

Install new reservoir in the reverse order of removal.







Once installed and cooler is reassembled completely, reattach water supply and plug unit into electrical outlet.

NOTE: Do not turn the cooling and heating switches on until at least two cups of water can be retrieved from each spout. Damage to heating and cooling system can result.

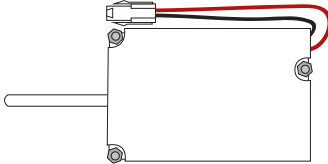
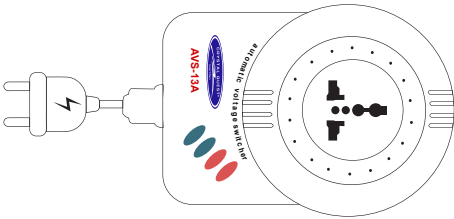
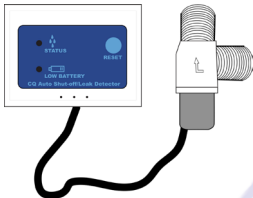
Please record the information below for your future reference

Plumber's Name/Company	Plumber's Address	Plumber's Telephone/E-mail

WATER COOLER OPTIONAL ACCESSORIES

<p>CQE-OZ-00101</p> 	<p align="center">Crystal Quest® Ozonator Sterilizer System</p> <p>Automatically sanitizes the cooler through a burst of ozone into the cooling tank and system. Ozonation kills any bacteria in a safe, odorless and taste free way. Ozone is a natural sterilization process that ensures your water is bacteria free. Once ozone has finished its sterilization job, it dissipates as oxygen and leaves your water oxygen enriched.</p>	
<p>CQE-PS-00102</p> 	<p align="center">Crystal Quest® Power Stabilizer</p> <p>The amount of power required for a Crystal Quest® Bottleless Water Cooler to operate is as follows: 110 Volts 60 Hertz Heating System – 500 Watts 6.2 Amps Cooling System – 112 Watts 2.4 Amps Total – 612 Watts 8.6 Amps</p> <p>This power requirement must be supplied at a constant rate to avoid damage. If a constant rate cannot be guaranteed then a power stabilizer is available to ensure this constant power requirement.</p>	
<p>CQE-PT-03060</p> 	<p align="center">Leak Detector Smart Valve®</p> <p>This Leak Detector Smart Valve claims to detect a water leak within a water cooler and shuts down the water supply in order to prevent flooding. The sensor is mounted inside the cartridge area of the cooler. If it detects wetness from a leak, it shuts down the water supply at the control box. The Leak Detector Smart Valve is a valuable tool in helping to prevent damage that can occur in the event that a leak occurs within the water cooler.</p>	
<p>CQE-PT-03059 Cup Holder</p>  <p>CQE-RC-03061 5 Oz Paper Cups (Available in quantities of 50 or 100)</p>	<p>CQE-RC-04054</p> <p>Crystal Quest® Alkalizer/Ionizer, Mineralizer and Oxidation Cartridge-Sealed</p> 	<p>CQE-RC-04060</p> <p>Crystal Quest® Water Cooler/Reverse Osmosis Fluoride Water Filter Cartridge</p> 
	<p>CQE-RC-04061</p> <p>Crystal Quest® Water Cooler/Reverse Osmosis Nitrate Water Filter Cartridge</p> 	<p>CQE-RC-04062</p> <p>Crystal Quest® Water Cooler/Reverse Osmosis Arsenic Water Filter Cartridge</p> 



REPLACEMENT CARTRIDGES

(All Floor Models) Ultrafiltration Cartridges		
Filters	Service Life	Part #
Cartridge #1 Sediment	Replace the cartridge as required or every 12 – 18 months depending on feedwater quality	CQE-RC-04037
Cartridge #2 Granulated Activated Carbon	Replace the cartridge as required or every 18 – 24 months depending on feedwater quality	CQR-RC-04038
Cartridge #3 UF Membrane	Replace the cartridge as required or every 18 – 24 months depending on feedwater quality	CQE-RC-04039
Cartridge #4 SMART	Replace the cartridge as required or every 24 – 36 months depending on feedwater quality	CQE-RC-04040
Optional UV Light	Replace the cartridge as required or every 12 – 18 months depending on feedwater quality	CQE-UV-00101
(All Floor Models) Reverse Osmosis Cartridges		
Cartridge #1 Granulated Activated Carbon	Replace the cartridge as required or every 18 – 24 months depending on feedwater quality	CQE-RC-04038
Cartridge #2 RO Membrane	Replace the cartridge as required or every 36 – 48 months depending on feedwater quality	CQE-RC-04041
Cartridge #3 UF Membrane	Replace the cartridge as required or every 18 – 24 months depending on feedwater quality	CQE-RC-04039
Cartridge #4 SMART	Replace the cartridge as required or every 24 – 36 months depending on feedwater quality	CQE-RC-04040
(Optional) UV Light	Replace the cartridge as required or every 12 – 18 months depending on feedwater quality	CQE-UV-00101
Turbo Countertop Replacement Cartridges		
Cartridge #1 SMART Mini Inline	Replace the cartridge as required or every 12 – 18 months depending on feedwater quality	CQE-RC-04057

*THIS REMINDER DECAL IS SPECIALLY PREPARED AS A REMINDER TO CHANGE THE CARTRIDGE ROUTINELY. USE A PEN TO FILL OUT THE INSTALLATION AND REPLACEMENT DATES. PEEL OFF STICKER AND AFFIX TO THE INSIDE LEFT OR RIGHT PANEL OF CARTRIDGE COMPARTMENT.



HOW TO AVOID ACCIDENTAL PROPERTY DAMAGE

Crystal Quest® Bottleless Water Coolers use the latest technologies available to ensure and prevent property damage. Property damage by Crystal Quest® systems is rare. However, if manufacturing guidelines are not followed water damage can occur. Causes of flooding include excessive water pressure, spikes in water pressure, human tampering and negligent installation.

To eliminate the possibility of water damage, use the following preventative steps and devices to keep our systems fail-safe:

1. A licensed plumber should install this unit, reading and following the Installation and Operation Guide as well as all notices.
2. Install a water pressure regulator/control valve inline to keep the water inflow pressure at 60 psi or less.
3. Install the auto shut-off valve (optional purchase) before the cooler to avoid excessive pressure. This will keep the pressure below 50 psi and may cause the system to vibrate when dispensing water.
4. If you are not sure if the pressure regulator is installed, install ball valve (provided with the unit) before the cooler to shut off water flow manually during non-business hours to ensure safety.
5. Use designated power supply for the unit; otherwise over- or under-amperage can cause malfunction of the high pressure solenoid, which can cause leaking or flooding.
6. If no designated power supply is available, a power stabilizer (available on the market or at www.crystalquest.com) should be purchased and used with unit.
7. Keep the plastic supply line tubing from rodent access, or use copper tubing.
8. Keep the water supply line tubing and other plastic tubes from heat. Maintain temperature at unit location between 35°F and 120°F.
9. Install an inline flood prevention valve/leak control (available on the market or at www.crystalquest.com).
10. In addition to having all other safety devices, shutting off the inflow water by use of an inline ball valve during non-business hours will ensure safety if the unit is accidentally or intentionally unplugged, moved or shocked (which could cause floater(s) failure).



IMPORTANT NOTICE

- The unit was inspected and properly packaged before leaving Crystal Quest® facilities and was free of any damage.
- Upon delivery, immediately inspect the carton and product(s) for evidence of rough handling and concealed damages. Report any damage to the carrier (company which delivers the product/s to customer), and file damage claims with the carrier immediately.
- Remove the carton, top packaging tray, and shipping bag from the system. Then remove the unit from the bottom inflammable packing material and carton tray. Make sure to inspect the system further, ensuring that:
 - a) There are no marks or physical damage to the system.
 - b) All accessories are present.
 - c) The hot tank switch is in the OFF position.
- All packages are insured. Should damaged merchandise arrive to you, you must take the following steps and file a claim with the carrier to avoid claim delays or denial. Purchaser is responsible for filing a claim with the carrier directly.
- If product was damaged during shipment, keep the original shipping cartons, packaging materials, and content; contact the carrier and request they pick up and return to Crystal Quest® for replacement. Also, file a claim with the carrier immediately. It is vital that you inspect the merchandise upon arrival and report the damage to the carrier to avoid denial or delay of claim. All claims for shipping damages must be made within five business days from delivery.
- If the merchandise was dropped off at your location (this is determined by seeing that the tracking information has a "delivered" status), Crystal Quest® cannot be held liable or responsible for lost, stolen, or damaged goods.
- Crystal Quest® cannot be held responsible or liable for damage to your property occurring during delivery by delivery company.

NOTE: Make sure the product has been standing in an upright position for 24 hours prior to installation.



i IMPORTANT NOTICE *CONTINUED*

GENERAL PROVISIONS AND EXCLUSIONS

- This warranty applies only within the continental limits of the United States of America.
- This warranty does not apply if service of the sealed refrigeration system or cold system or parts furnished as original equipment by Crystal Quest® is not obtained from approved service center or the factory.
- This warranty does not apply to any water components that become inoperative due to limiting conditions.
- This warranty does not apply to any water cooler or components that become inoperable because of a failure to satisfy standards or regulations adopted by any government or agency thereof subsequent to the date of shipment.
- This warranty does not cover performance, failure, or damage of any part resulting from external causes such as alteration, abuse, misuse, misapplication, corrosion, or act of God.

WARNING

The warranty and the CE listing for this machine are automatically voided if this machine is modified or combined with any other machine or device. Alteration or modification of this machine may cause serious flooding and/or hazardous electrical shock or fire.

Except as set forth herein, the Manufacturer makes no other warranty, guarantee, or agreement expressed, implied or statutory, including implied warranty of merchantability or fitness for a particular purpose.

The foregoing is in lieu of all other agreements expressed, implied or statutory and all obligations or liabilities of the Manufacturer. The Manufacturer does not assume or authorize any person to assume any obligations of liability in connection with this product. In no event will Manufacturer be liable for special or consequential damages or for any delay in the performance of this agreement due to causes beyond their control.

FILTER AND R/O MEMBRANE / LIMITED WARRANTY / FILTER WARRANTY

Subject to conditions and limitations described below, Crystal Quest® warrants the filters to be free from defects in material and workmanship under normal use within the operating specifications in the "Installation and Operation Guide."

Filters/cartridges/membranes under warranty will be repaired or replaced and returned upon inspection by Crystal Quest®.

CONDITIONS OF FILTER WARRANTY

The above warranty will not apply to the filters, cartridges, or R/O membranes that are damaged because of neglect, misuse, alteration, accident, and misapplication, fouling, and/or scaling of membrane by minerals, bacteria attack, sediment, or damage caused by fire, act of God, freezing, or hot water. If the filters/cartridges/membranes is/are altered by anyone other than Crystal Quest®, the warranty is voided. Crystal Quest® assumes no warranty liability in connection with the reverse osmosis or filter system other than specified herein. Crystal Quest® will not be liable for any consequential damages of any kind or nature of Crystal Quest® products.



INSTALLING LEAK DETECTOR

POWER REQUIREMENT

The power required for a Crystal Quest® Bottleless Water Cooler to operate properly is:

U.S. STANDARD

110 Volts, 60 Hertz

Heating System - 500 Watts, 6.2 Amps

Cooling System - 112 Watts 2.4 Amps

Total - 612 Watts, 8.6 Amps

EUROPEAN STANDARD

220 Volts, 50 Hertz

Heating System - 500 Watts, 6.2 Amps

Cooling System - 112 Watts 2.4 Amps

Total - 612 Watts, 8.6 Amps

Leak detector detects water leaks within a water cooler and shuts down the water supply to prevent flooding.

Features:

- Water leak control with auto shut-off and alarm
- 9V alkaline battery operated
- Available in 1/4", 3/8" or 1/2" BSP connections
- Auto shut-off when battery power is low

If there is not a designated circuit, not enough amps, or if power fluctuates, a power stabilizer is needed to avoid damage. The water heater will repeatedly shut down prior to burnout. It also causes solenoid malfunction which causes constant water discharge (flooding).

OTHER IMPORTANT INFORMATION

- Crystal Quest® Reverse Osmosis Bottleless Water Coolers have a limited production* of permeate/filtered water per 24 hours. It may take up to two hours for the cooling and heating reservoirs to fill initially.
- During peak demand, the reservoirs may take longer to heat and cool.

*Daily permeate product may be 50, 75, or 100 gallons, based on the R.O. membrane ordered.

**R.O. water coolers require a drain line to discharge concentrated/waste water.

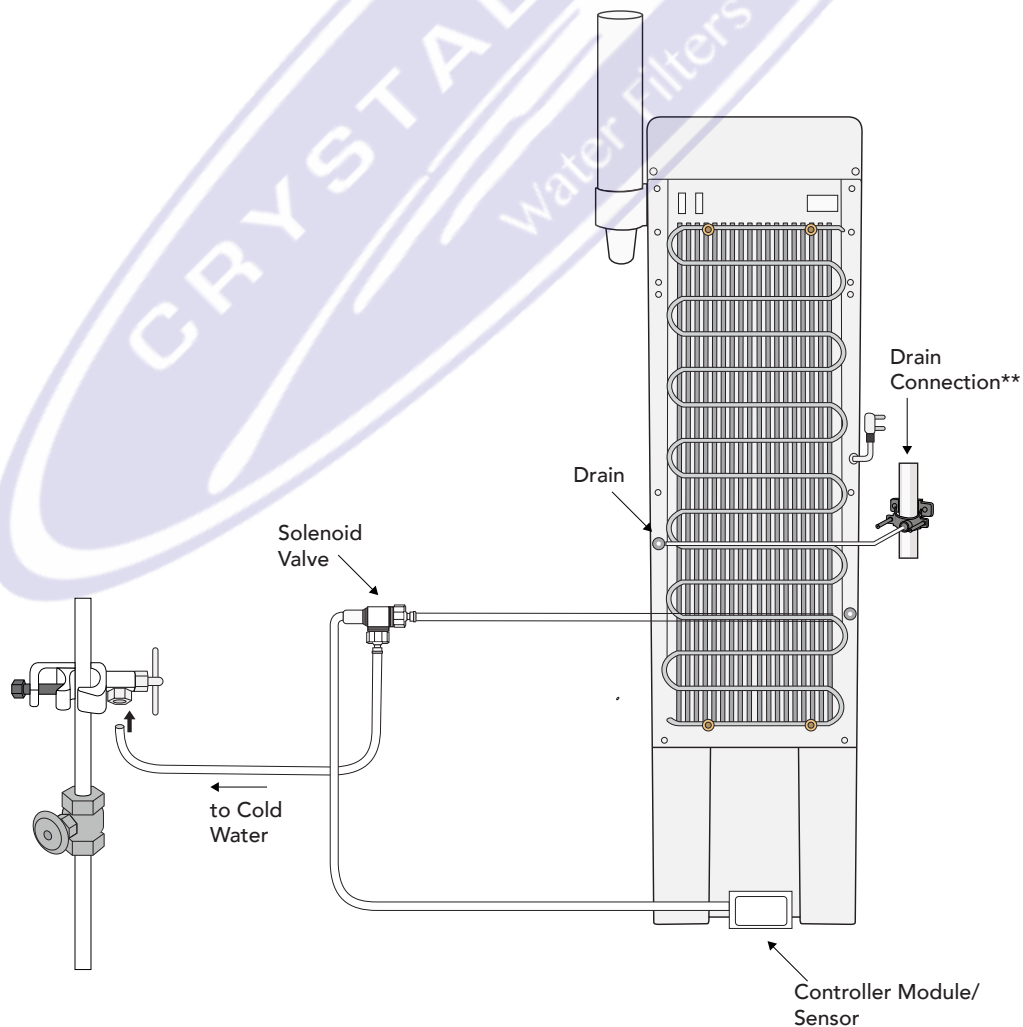



FREQUENTLY ASKED QUESTIONS

Q: What pressure range does my Water Cooler run in?

A: Each of our Water Cooler units are designed to run between 30 – 60 psi.

Q: Can I sit my cup or bottle on the Drip Tray when filling it?

A: Do not use the Drip Tray to support any type of container when filling from the unit.

Q: How can I remove the tubing from a Compression Fitting?

A: Compression Fittings are the style of fitting found on all of our Filter Cartridges, each one marked by a distinctive hexagon-shaped plastic cap. To remove the tubing: Unscrew the plastic cap by turning it counterclockwise, then removing both the cap and the tubing from the fitting. Be cautious not to over-tighten the cap when reinstalling the tubing to the fitting.

Q: How can I remove the tubing from a Quick Connect Fitting?

A: Quick Connect Fittings are the style of fitting found on most of the internal components of your unit, each one marked by a distinctive blue clasp directly below the lip of the fitting inlet. To remove the tubing: Locate the small blue clasp and remove it. Next you will press down on the lip of the fitting with one hand while gently pulling the tubing out with the other. To replace the fitting: Press down on lip of the fitting, push the tubing firmly in, release the fitting lip, then reinstall the blue clasp.

Q: My Reverse Osmosis Membrane looks different from the other filters, how to I replace it?

A: The Reverse Osmosis Membrane is the only filter on the machine that needs to be removed from its housing when being replaced. Unscrew the Membrane cap from the housing, turning counterclockwise to loosen. Once the cap is off, remove the previous RO Membrane by lifting it from the housing with a pair of pliers by its exposed nozzle. Next install the new Membrane, making sure to insert it into the housing by the nozzle which has the two small o-rings, pictured below:

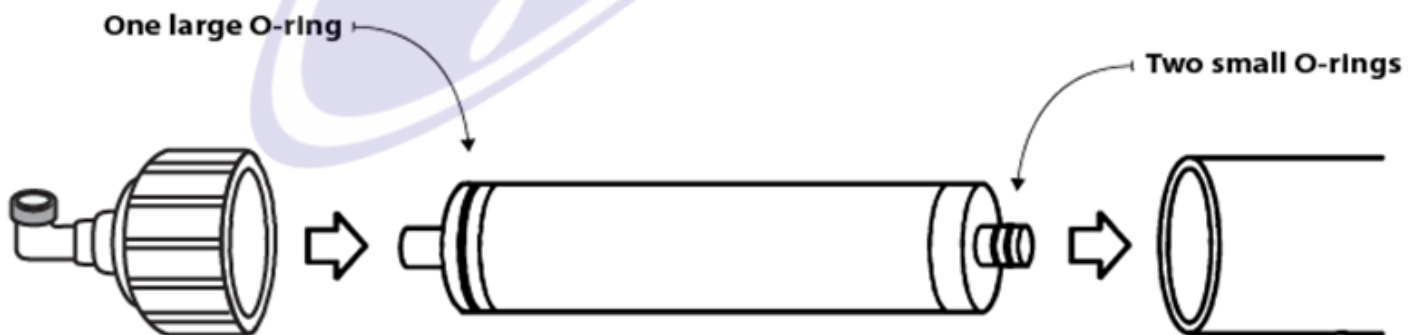

Q: What is the exact layout of the cartridges in my specific Water Cooler?

A: Match your Unit to the corresponding diagram below via the Units name or product SKU (see next page):



FREQUENTLY ASKED QUESTIONS *CONTINUED*

Crystal Quest Watercooler Configurations

Component Guide

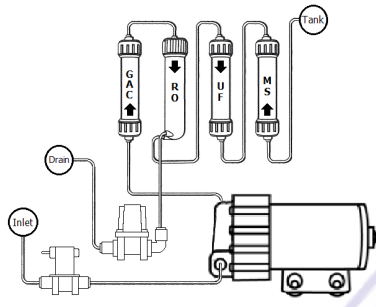
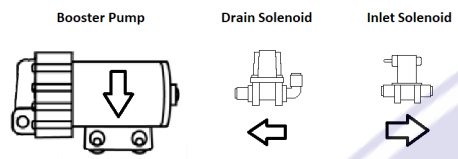

Sharp & Turbo RO/UF

Sharp	Premium	CQP-WC-05900
	Standard	CQE-WC-00910
Turbo	Premium	CQP-WC-05901
	Standard	CQE-WC-00907

Turbo Countertop

Standard	CQE-WC-00908
----------	--------------

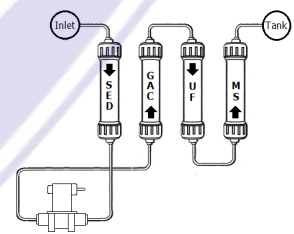

Sharp & Turbo UF

Sharp	Premium	CQP-WC-05902
	Standard	CQE-WC-00909
Turbo	Premium	CQP-WC-05903
	Standard	CQE-WC-00906

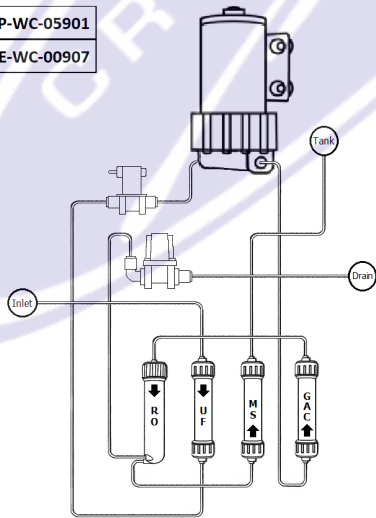

Hybrid RO/UF

Standard	CQE-WC-00902
----------	--------------

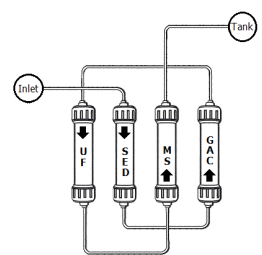

Hybrid UF

Standard	CQE-WC-00900
----------	--------------



FREQUENTLY ASKED QUESTIONS *CONTINUED*

Q: Why doesn't my water cooler produce hot/ cold water?

A: COOLING: The first thing you are going to want to do is check the back of the water cooler to see if both cooling element switch is turned to the "on" position. If it is, you will need to locate the thermostat screw at the top of the water cooler. It would be behind the yellow sticker at the top of the system labeled "Thermostat". Turn that screw counterclockwise (to the left) to lower the thermostat and allow the compressor to kick on. You may not hear the compressor kick on at first, but give the system at least 15 minutes before testing the cold-water spout. This should take care of the issue but if not, call us directly to speak to Technical Support.

HEATING: What you are going to want to do is make sure the heating element switch is turned to the "on" position in the back of the water cooler. If the switch is turned to the "on" position, locate the heating tank (towards the middle of the tank). There will be two sets of wires connected to the back of the tank. Look at the second set of wires (the bottom set). There will be a small black button between the set of wires which would be the heating tank reset switch. Press and hold that reset switch for 5 seconds and allow the tank 15 minutes to start the heating process before testing the hot water spout. This should take care of the issue but if not, call us directly to speak to Technical Support.

Q: I am experiencing a leak with my water cooler, why?

A: When experiencing a leak within your system, you want to figure out exactly where the leak is coming from. If this is a floor standing water cooler, open the front panel of the system to reveal the cartridges. Check each connection between the filters to make sure they are secure. If the connections or the cartridges are the problem, call us directly to speak to a technician. If your connections and cartridges are not the cause for the leak, remove the hat (top) of the water cooler to expose the reservoir tank. You can access the top of the reservoir tank by removing the screws at the back of the water cooler towards the top. After you have taken off the hat of the water cooler, remove the transparent plastic lid on top of the reservoir tank. If the tank is full and you still hear the pump trying to produce water, call in directly to speak to a technician to help solve the issue for you. These are the primary areas that would cause the system to leak, however, if you have checked both areas and cannot identify where the leak is originating from, call us to speak to a technician.

Q: Why aren't the element lights on?

A: If your water cooler element (Heating/ Cooling) lights are not on, check the back of the water cooler to make sure the element switches are turned to the "on" position. If they are turned to the "on" position and still not allowing the element lights to come on, check the power source to make sure the water cooler is plugged in. IF the water cooler is plugged in and still not lighting up, call us directly to speak to a technician as you may need to replace the fuse.



ONE-YEAR LIMITED WARRANTY

CRYSTAL QUEST® warrants your CRYSTAL QUEST® Point-of-Use Bottleless Water Cooler for one year from the date of purchase against all defects in materials and workmanship when used in compliance with the manual. This warranty does not include replacement cartridges unless defective upon receipt. CRYSTAL QUEST® disclaims all implied warranties including, without limitation, warranties of merchantability and fitness for a particular purpose. If for any reason the product proves to be defective within one year from the date of purchase, please call for assistance. This warranty gives you specific legal rights and you may have other legal rights which vary from state to state. CRYSTAL QUEST® assumes no responsibility for incidental or consequential damages; for damages arising out of misuse of the product, or the use of any unauthorized attachment. Some states do not allow the exclusion or limitation of implied warranties or incidental or consequential damages; therefore, the above limitations or exclusions may not apply to you. Should service be required during or after the warranty period or should you have any questions regarding how to use your CRYSTAL QUEST® Point-of-Use Bottleless Water Cooler, please contact our Technical Support Department at service@crystalquest.com, Monday through Friday, 9 AM to 5 PM Eastern Time.

YOUR PURCHASE INFORMATION

KEEP THIS MANUAL FOR FUTURE REFERENCE AND UNIT MAINTENANCE

Online warranty information
<http://crystalquest.com/warranty.htm>

Product design is subject to change without notice.

For further assistance, contact your Crystal Quest dealer
or visit us at www.crystalquest.com

To view the latest edition of the Point-Of-Use Bottleless Water Coolers Guide, visit CrystalQuest.com

Please note all drawings, pictures, colors and sizes are approximate for illustrative purposes only and may not exactly resemble the end product.